

tabi™

installation instructions tabi weave

safety requirements

Tabi weave - Wall Mounted Frameless Dry Erase Board, Non-Seismic Applications

The building's Engineer of Record must be consulted to determine if there are any seismic requirements.

	CAUTION! CRUSH HAZARD. Failure to properly secure board could result in personal injury.
	ATTENTION! RISQUE D'ÉCRASEMENT. Ne pas attacher la planche de manière sûre pourrait entraîner des blessures personnelles.
SAFETY INSTRUCTIONS	
Read all assembly direction before beginning installation. Building construction varies greatly. The Building's Engineer of Record is responsible for the design of building walls which the boards are attached to and must verify the adequacy of the mounting hardware, even if provided by the manufacturer. The building owner or designated agent is responsible for verifying that the installation is in compliance with all local codes and regulations.	
INSTRUCTIONS DE SÉCURITÉ	
Lisez l'ensemble des instructions d'assemblage avant de démarrer l'installation. La construction des bâtiment varie grandement. L'ingénieur d'enregistrement du bâtiment est responsable de la conception des murs sur lesquels sont attachées les planches et doit vérifier que le matériel de montage est adéquat, même si ce dernier est fourni par le fabricant. Le propriétaire du bâtiment ou l'agent désigné a la responsabilité de vérifier que l'installation est conforme a l'ensemble des codes et réglementations locaux.	

Verify Wall Construction

- CAUTION! Adequate wall construction is required to support the weight of the board. Minimum wall construction must be capable of supporting weight amounts listed in Table 1.

Minimum Required Wall Construction



Drywall with metal studs:

- Must be at least 25 ga. (0.018" thick) 33 ksi steel studs (1.5" x 3.5")
- Studs on maximum 24" centers
- Must be at least 5/8" thick Type X gypsum drywall
- #6 x 1-1/4" drywall screws on 12" centers

Drywall with wood studs:

- Stud grade SPF, DF-L or Hem-Fir (1.5" x 3.5")
- Studs on 24" centers
- Must be at least 5/8" thick Type X gypsum drywall
- #6 x 1-1/4" drywall screws on 12" centers

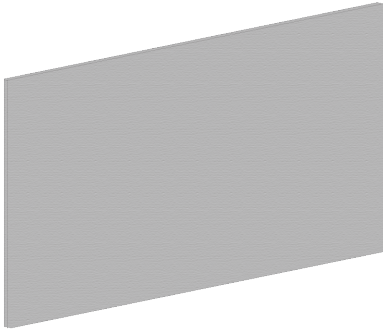
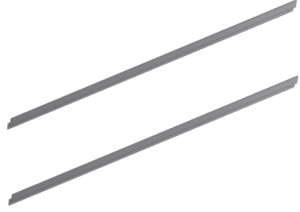
required materials & equipment

Required Equipment	Materials Provided
<ul style="list-style-type: none"> • Drill • #2 Bit • Pliers • Pencil • Level • 2 or 3-step ladder • Tape measure 	<p>NOTE: Items are not drawn to size. Quantity of wall anchors and screws will vary per product due to the various widths. Board size determines the quantity of anchors and screws.*</p> <div style="display: flex; justify-content: space-around; align-items: center;"> <div style="text-align: center;">  <p>weave panel(s)</p> </div> <div style="text-align: center;">  <p>brackets*</p> </div> </div> <div style="display: flex; justify-content: space-around; align-items: center; margin-top: 20px;"> <div style="text-align: center;">  <p>1-1/4" self drilling screws*</p> </div> <div style="text-align: center;">  <p>wall anchors*</p> </div> </div>

Before starting the installation of Weave, verify that the required equipment is available and material provided is accurate.

1. Provide adequate protection for finished floor surfaces.
2. All Weave installations should be carried out by two or more individuals.

***Table 1**

Size / Orientation	Brackets	Anchors/ Screws
24" x 24"	2	6
36" x 48" horizontal	2	12
48" x 72" horizontal	2	18
48" x 96" horizontal	2	24
48" x 36" vertical	2	10
72" x 48" vertical	2	12
96" x 48" vertical	2	12

installation instructions

step one

Use appropriate mounting specification based on the size and the orientation of your Weave board

NOTE: You may drill holes in the support bracket to install into the wall stud for strongest support. Anchor into wall studs as often as possible. Mounting heights are recommendations only.

Size	# of studs	Weight
24" x 24"	2	5 lbs
36" x 48"	2	17 lbs
48" x 72"	3	62 lbs
48" x 96"	4	80 lbs
48" x 36"	2	17 lbs
72" x 48"	2	62 lbs
96" x 48"	2	80 lbs

Recommended Mounting Heights

Horizontal Orientation

Size	A	B
24" x 24"	75-9/16"	18-1/4"
36" x 48"	75-9/16"	30-1/4"
48" x 72"	75-9/16"	42-1/4"
48" x 96"	75-9/16"	42-1/4"

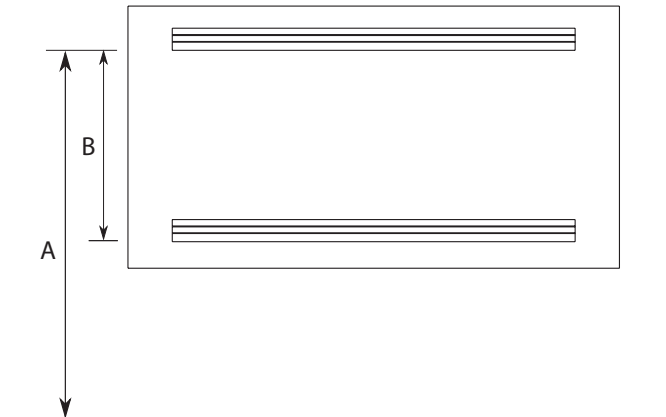

Vertical Orientation

Size	C	D
48" x 36"	75-9/16"	42-1/4"
72" x 48"	68-11/16"	66-1/4"
96" x 48"	75-9/16"	90-1/4"

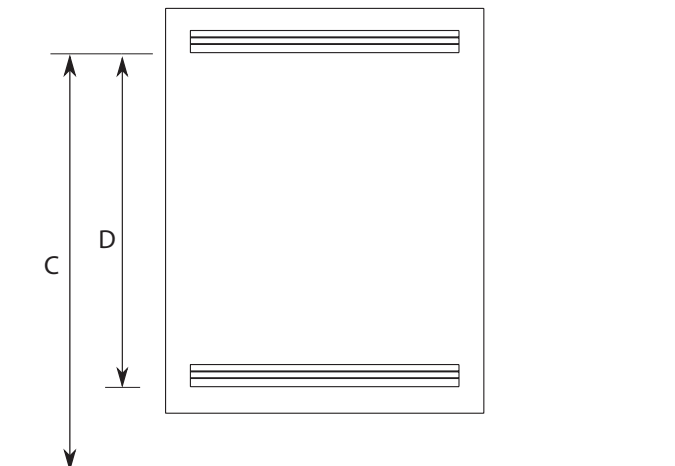

installation instructions

step two

Level brackets and mark holes onto wall.
Refer to recommended mounting heights
noted on page 4.

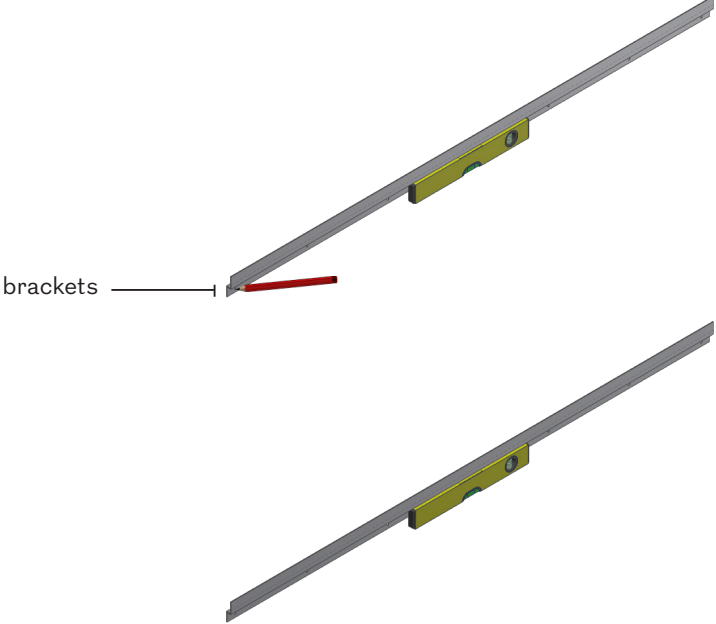

step three

Remove brackets from wall and install wall
anchors in all hole locations that are not over
a stud. Anchor may not be needed for stud.

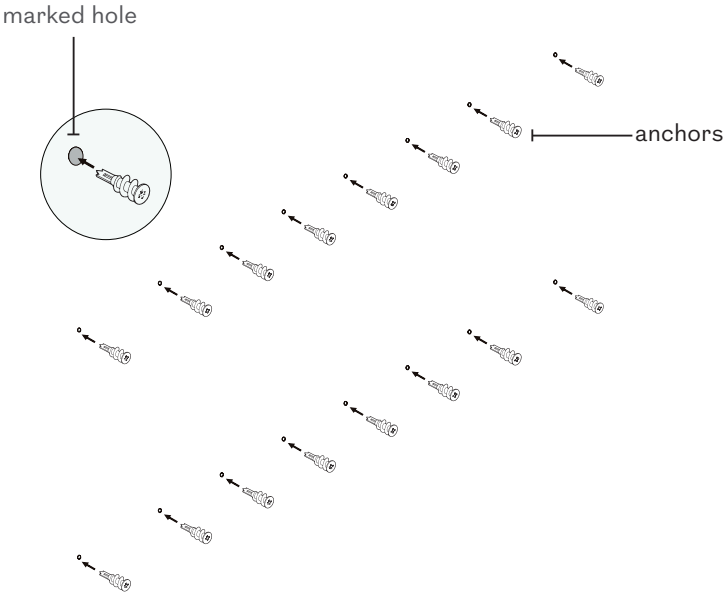

installation instructions

step four

Re-align brackets with holes and secure using screws.

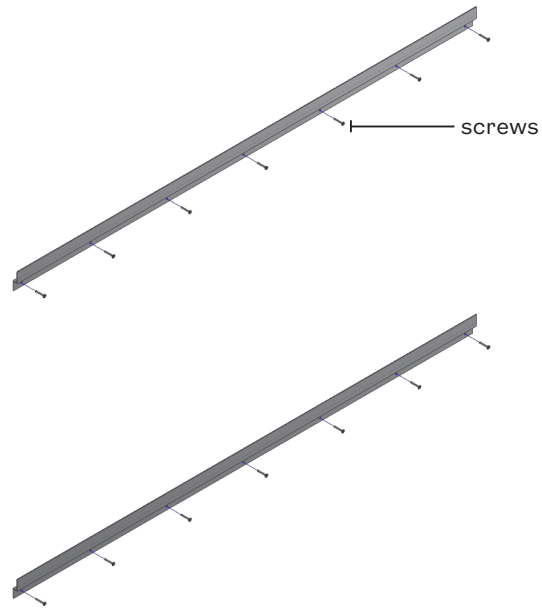

step five

Lower brackets on back of the Weave board onto brackets on wall.

IMPORTANT: Always check to insure both top and bottom panel brackets are resting on the wall brackets.

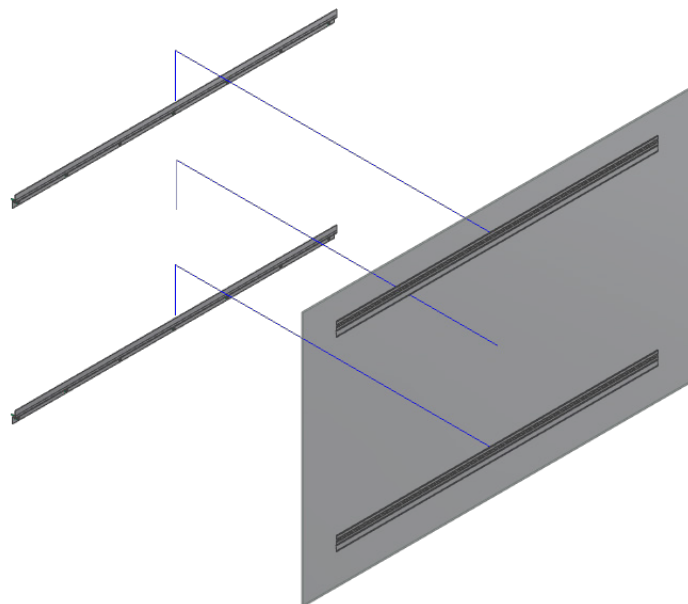

installation instructions

step five continued

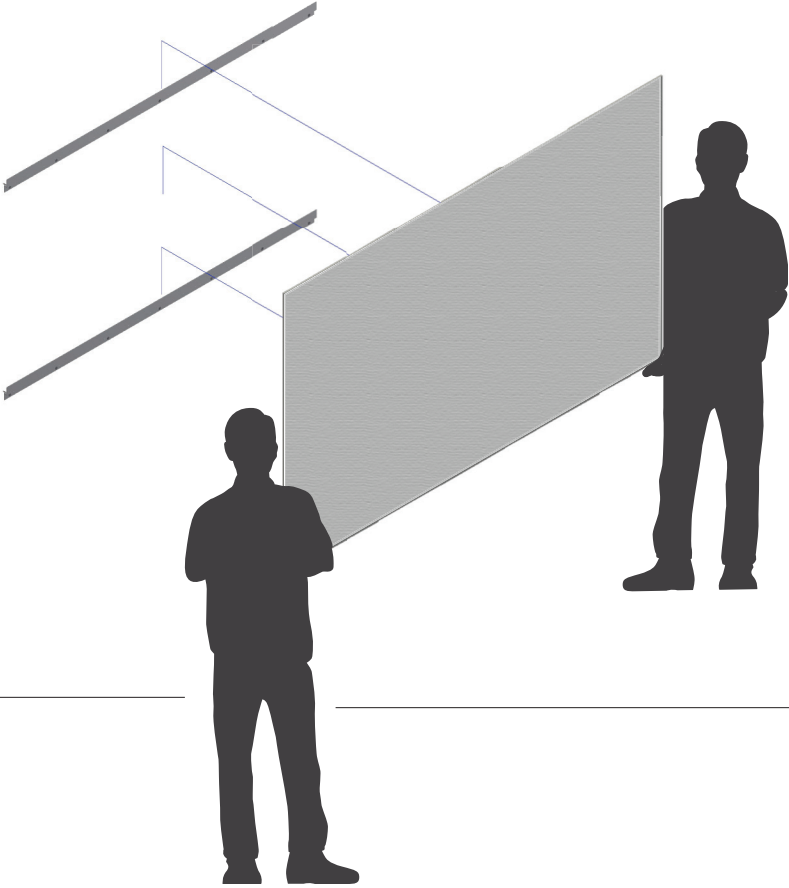

Installation of Weave is now complete.

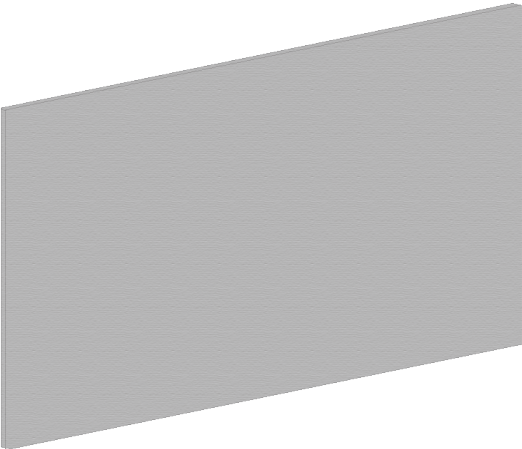

1 888 325 6351
info@tabiforteams.com
tabiforteams.com

©2020 PolyVision Corporation. All rights reserved. Trademarks used herein are the trademarks of PolyVision Corporation or their respective owner. PolyVision Corporation reserves the right to make changes in product design, construction or detail, and to discontinue any product or material without notice. Tabi products are manufactured by PolyVision Corporation.
